

1200 SERIES ENTRANCE
DOOR TYPES/SECTION DIMENSIONS

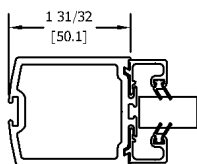

NARROW STYLE

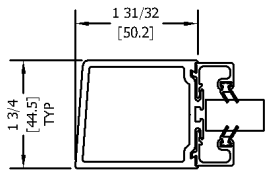
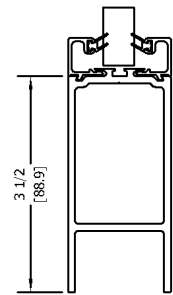
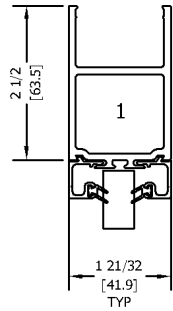
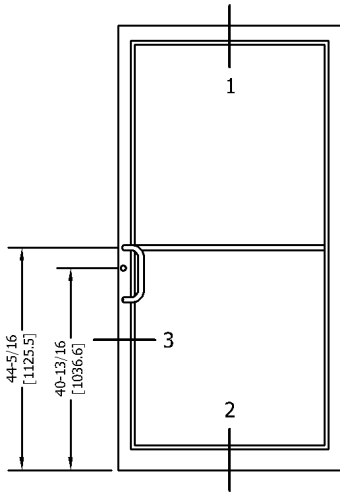

MEDIUM STYLE

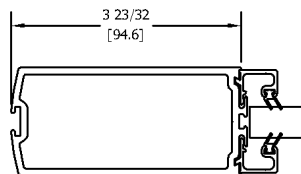
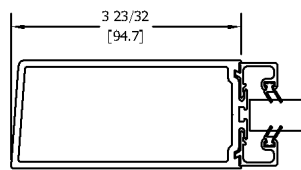
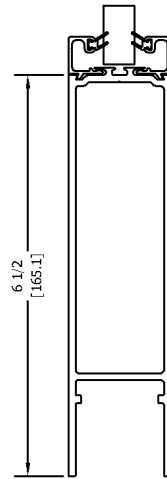
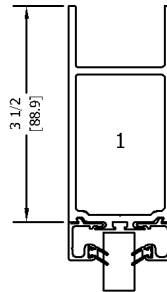
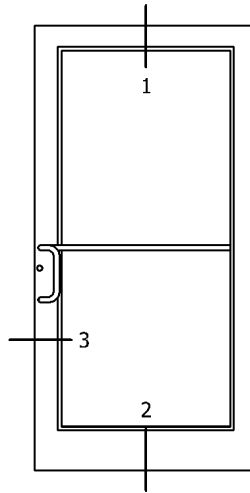



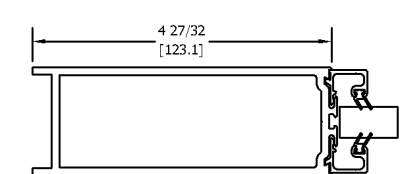
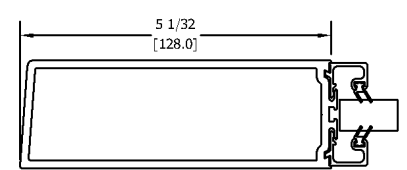
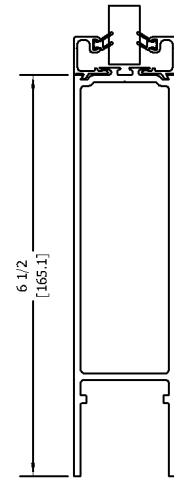
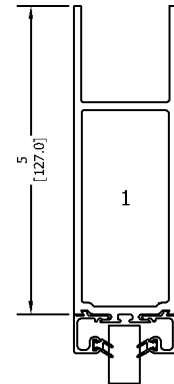
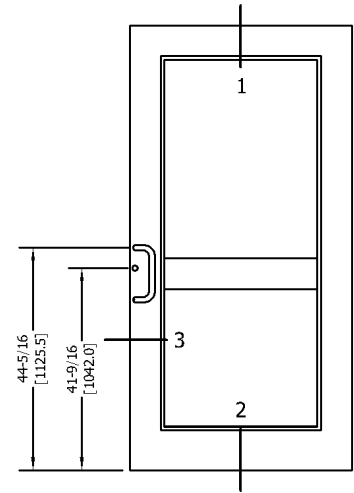







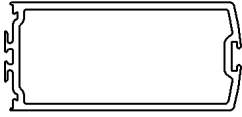

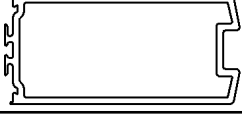
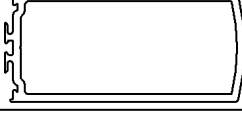
WIDE STYLE





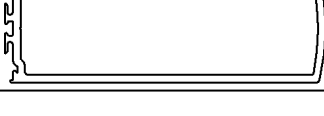





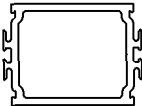

1200 SERIES ENTRANCE
DOOR

PART NUMBER	DIE DRAWING	WT/FT	PERMIETER	X-X	Y-Y
BCE-1201		1.105	11.714	0.548 I 0.367 S	0.387 0.469
BCE-1202		1.496	14.872	1.391 I 0.670 S	0.565 0.679
BCE-1203		1.368	13.734	1.427 I 0.724 S	0.517 0.637
BCE-1204		0.944	9.182	0.286 I 0.285 S	0.337 0.385
BCE-1205		0.976	8.340	0.435 I 0.406 S	0.354 0.398
BCE-1206		1.006	9.395	0.451 I 0.429 S	0.351 0.400
BCE-1207		0.965	8.757	0.436 I 0.523 S	0.348 0.398
BCE-1208		1.033	9.203	0.439 I 0.427 S	0.356 0.407
BCE-1209		1.024	8.915	0.491 I 0.444 S	0.373 0.426
BCE-1210		0.323	6.630	0.005 I 0.012 S	0.079 0.096
BCE-1211		1.942	17.852	3.859 I 1.383 S	0.777 0.940
BCE-1213		2.189	21.177	7.651 I 2.215 S	0.920 1.115
BCE-1214		1.565	12.695	1.915 I 1.019 S	0.655 0.749
BCE-1215		1.438	12.350	2.112 I 1.071 S	0.614 0.694

1200 SERIES ENTRANCE
DOOR

PART NUMBER	DIE DRAWING	WT/FT	PERMIETER	X-X	Y-Y
BCE-1216		1.468	12.902	2.182 I 0.610 1.128 S 0.697	
BCE-1217		1.427	12.265	2.098 I 0.608 1.058 S 0.695	
BCE-1218		1.495	12.711	2.192 I 0.615 1.154 S 0.703	
BCE-1219		1.624	12.415	2.437 I 0.686 1.220 S 0.784	
BCE-1221		1.984	16.730	4.278 I 0.791 1.595 S 0.959	
BCE-1222		2.734	22.869	12.595 I 1.162 3.185 S 1.400	
BCE-1223		3.482	46.962	0.436 I 0.348 0.523 S 0.398	
BCE-1224		1.958	15.321	4.397 I 0.872 1.733 S 0.997	
BCE-1225		2.005	14.970	1.736 I 0.732 0.662 S 0.829	
BCE-1229		2.017	15.039	5.196 I 0.903 1.951 S 1.032	
BCE-1230		0.122	3.883	0.005 I 0.002 0.014 S 0.005	
BCE-1231		0.114	3.252	0.004 I 0.001 0.012 S 0.005	
BCE-1232		0.131	4.121	0.006 I 0.004 0.016 S 0.012	
BCE-1233		0.140	2.386	0.001 I 0.352 0.004 S 0.013	

1200 SERIES ENTRANCE
DOOR

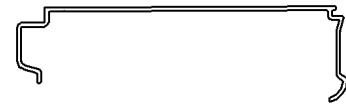
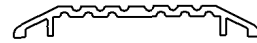
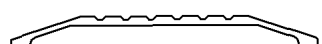
PART NUMBER	DIE DRAWING	WT/FT	PERMIETER	X-X	Y-Y
BCE-1234		1.120	10.284	0.573 I 0.352 0.509 S 0.426	
BCE-1235		1.748	14.284	3.077 I 0.653 1.414 S 0.790	
BCE-1236		0.180	5.537	0.003 I 0.041 0.009 S 0.055	
BCE-1237		0.142	3.892	0.018 I 0.002 0.027 S 0.004	
BCE-1238		0.392	3.338	0.002 I 0.051 0.015 S 0.069	
BCE-1239		0.374	3.339	0.012 I 0.018 0.024 S 0.038	
BCE-1240		0.212	5.275	0.001 I 0.036 0.007 S 0.044	
BCE-1241		0.436	6.107	0.027 I 0.129 0.034 S 0.117	
BCE-1242		0.455	6.379	0.027 I 0.152 0.034 S 0.131	
BCE-1243		0.145	4.379	0.011 I 0.004 0.024 S 0.012	
BCE-1244		2.088	31.982	0.661 I 14.914 0.619 S 3.848	
BCE-1245		0.683	16.783	0.106 I 2.132 0.085 S 0.784	
BCE-1341		0.692	10.802	0.823 I 0.010 0.412 S 0.030	
A-444		0.840	11.263	0.015 I 1.567 0.041 S 0.627	

1200 SERIES ENTRANCE
DOOR

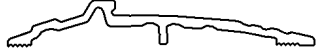

PART NUMBER	DIE DRAWING	WT/FT	PERMIETER	X-X Y-Y
A-482	 A technical line drawing of an aluminum extrusion profile, showing a complex cross-section with multiple flanges and a central channel.	0.973	11.952	0.023 I 1.680 0.054 S 0.665

1200 SERIES ENTRANCE
NARROW STILE DOOR

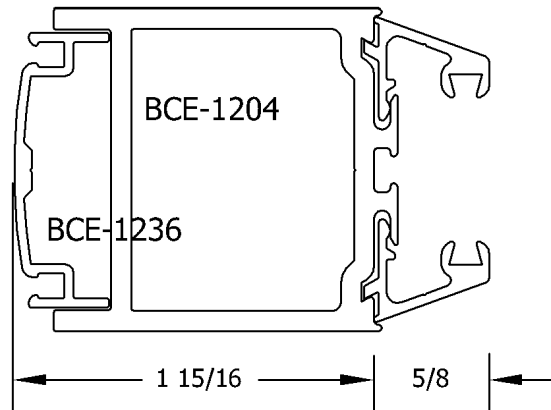
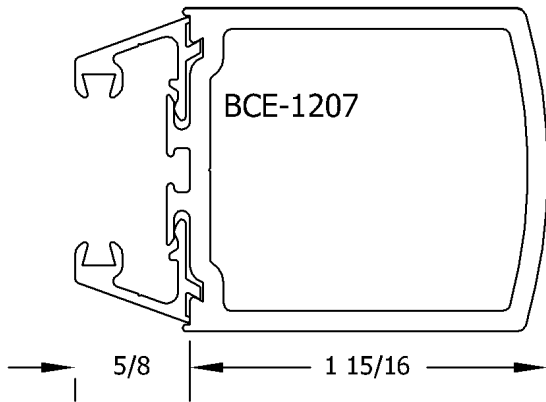
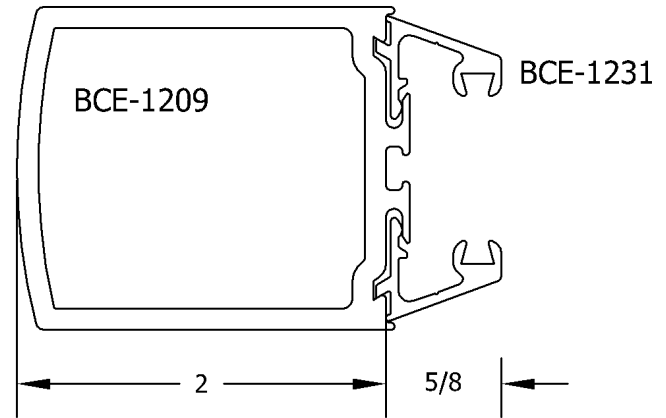
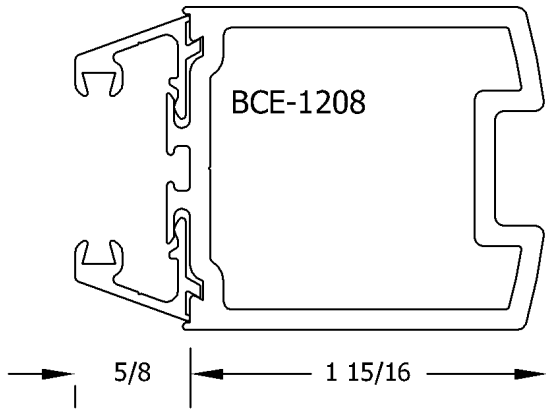
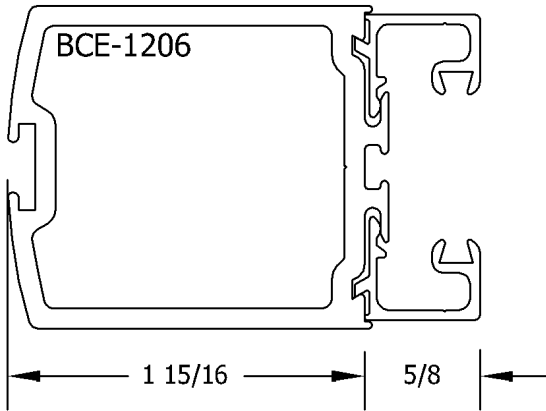
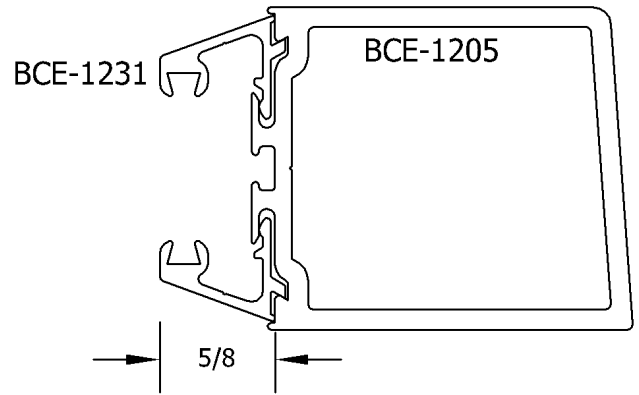
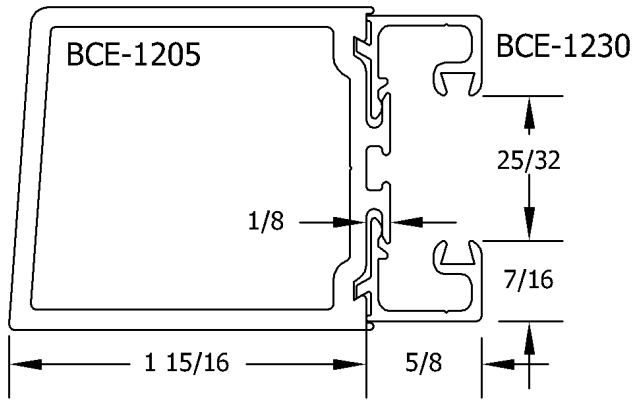

1200 SERIES ENTRANCE TOP AND BOTTOM RAILS

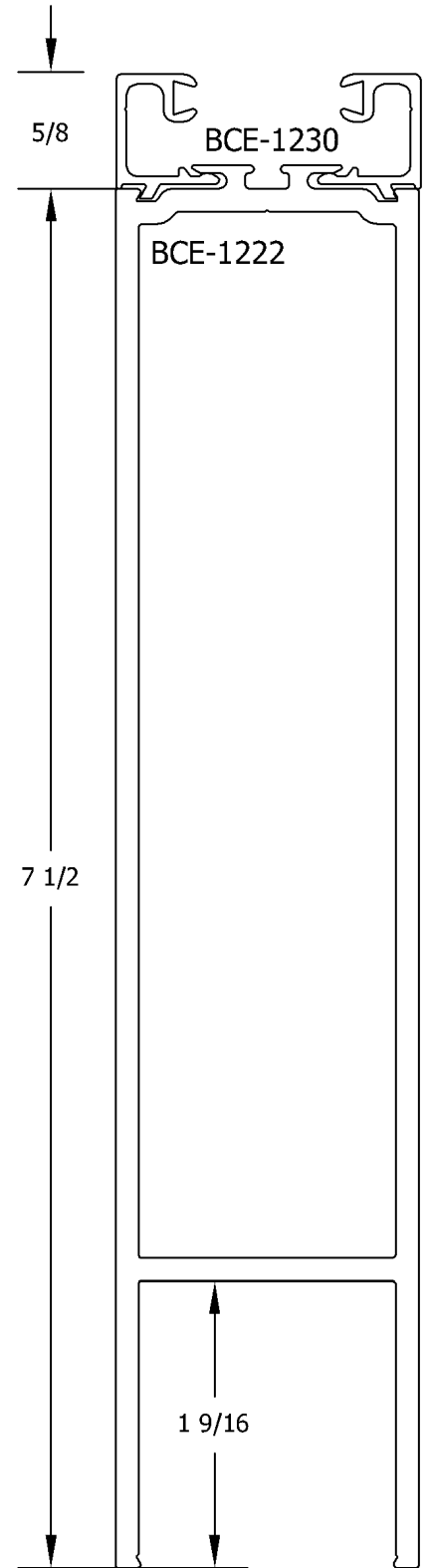
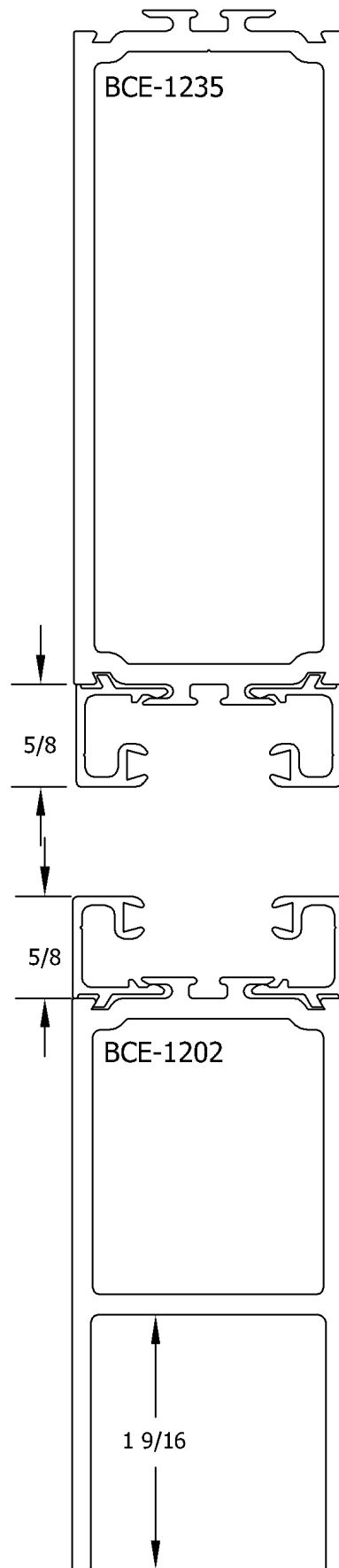
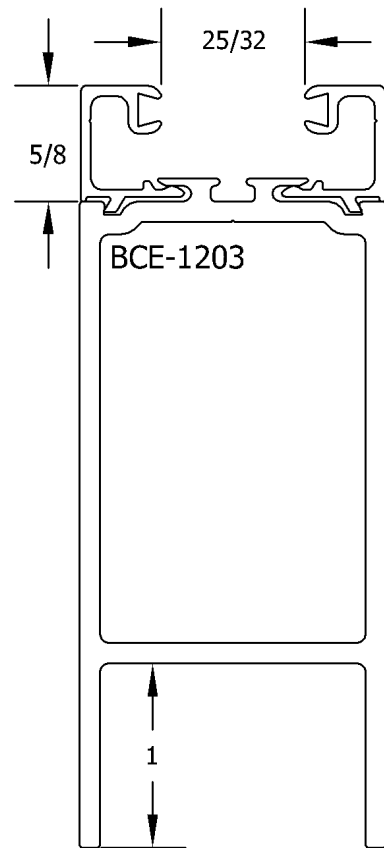
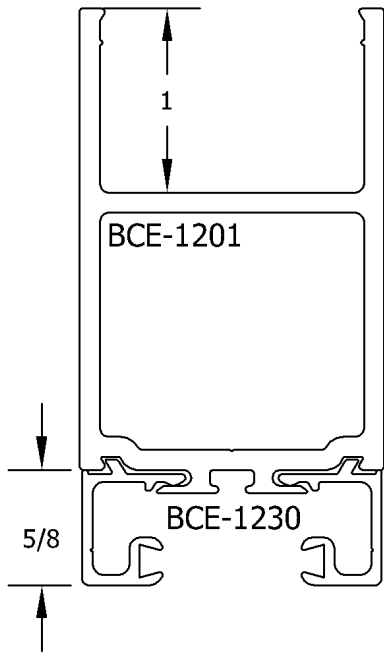

1200 SERIES ENTRANCE
MEDIUM STILE DOOR

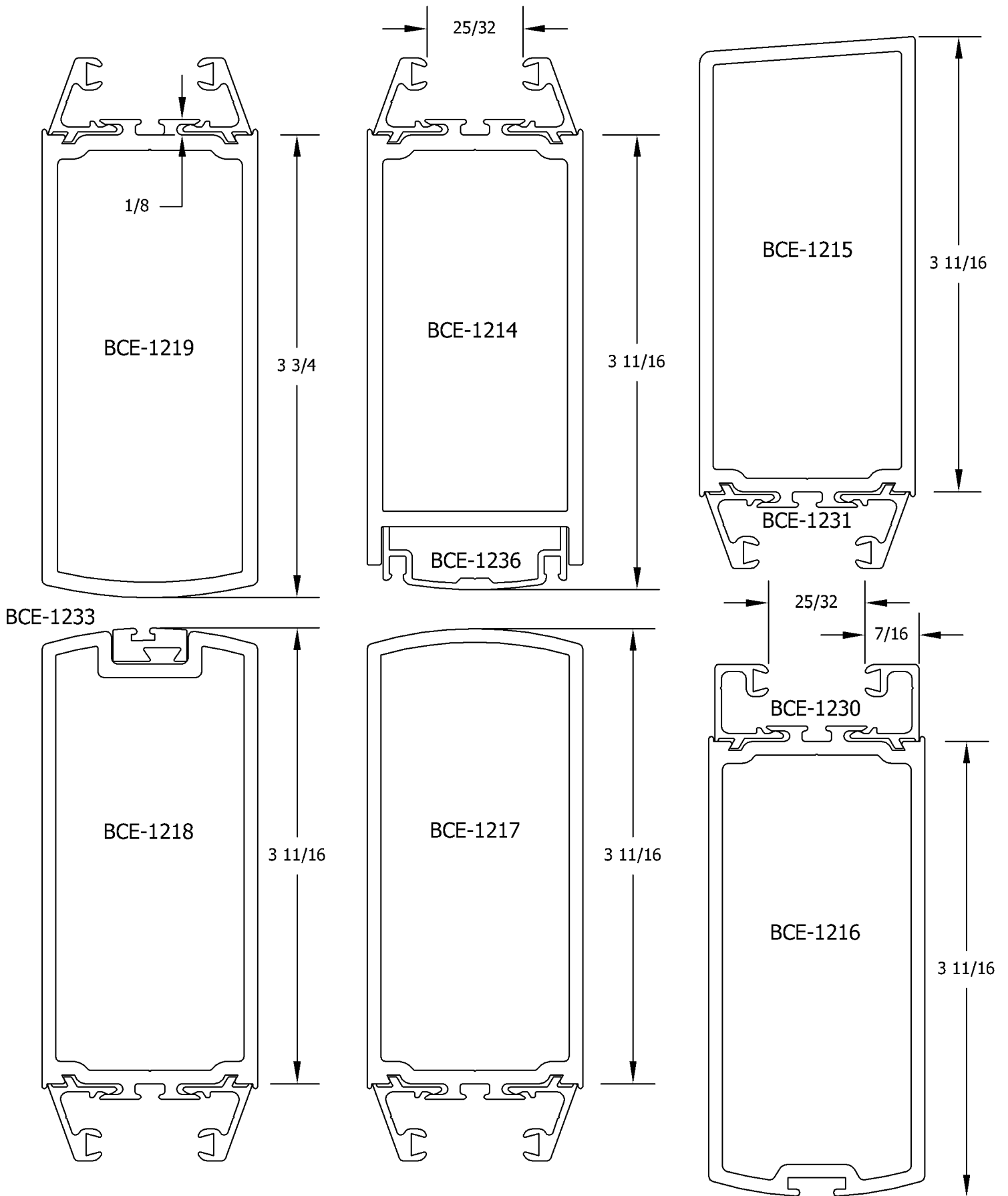

1200 SERIES ENTRANCE
TOP AND BOTTOM RAILS

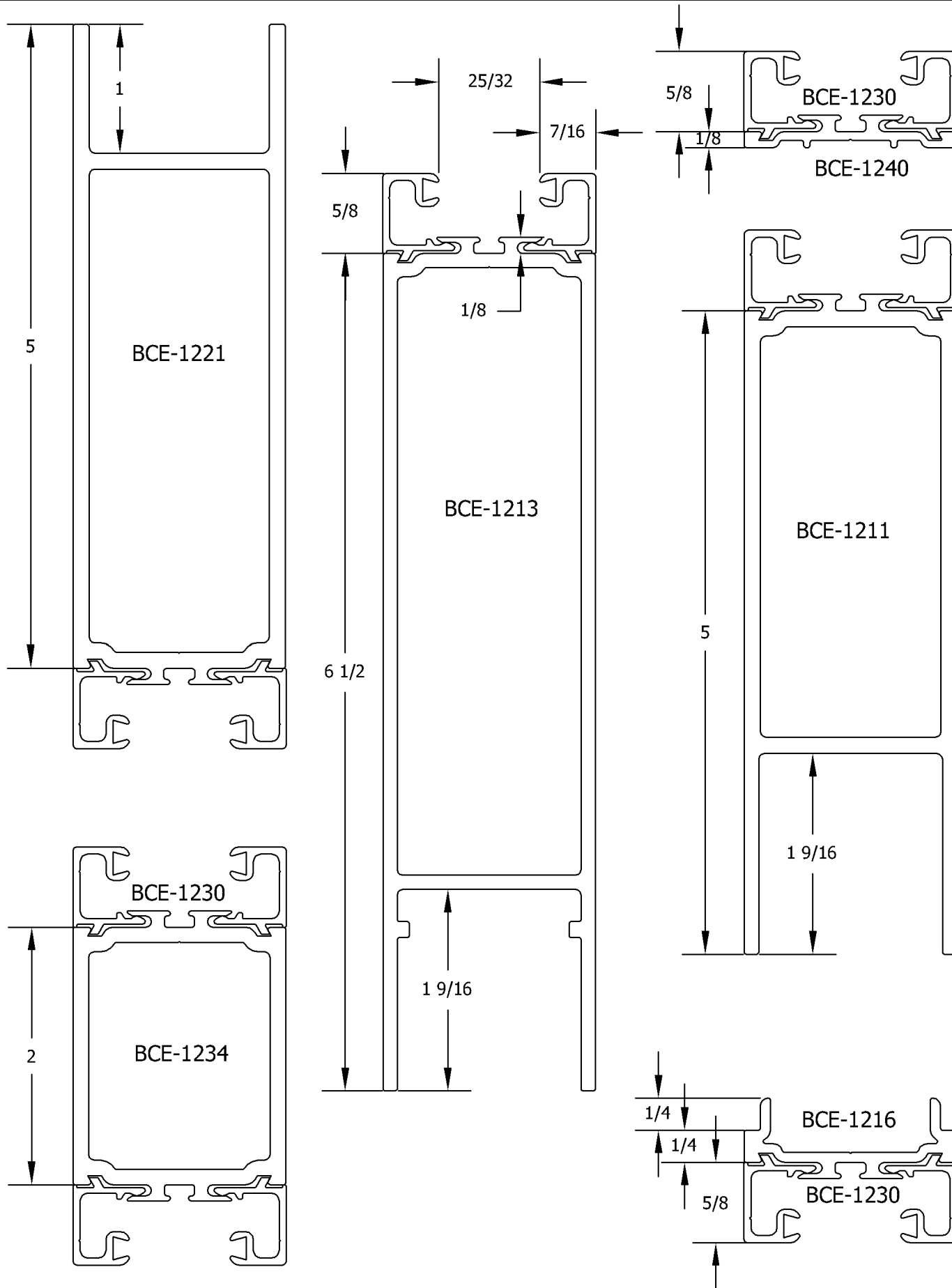

1200 SERIES ENTRANCE
WIDE STILE DOOR

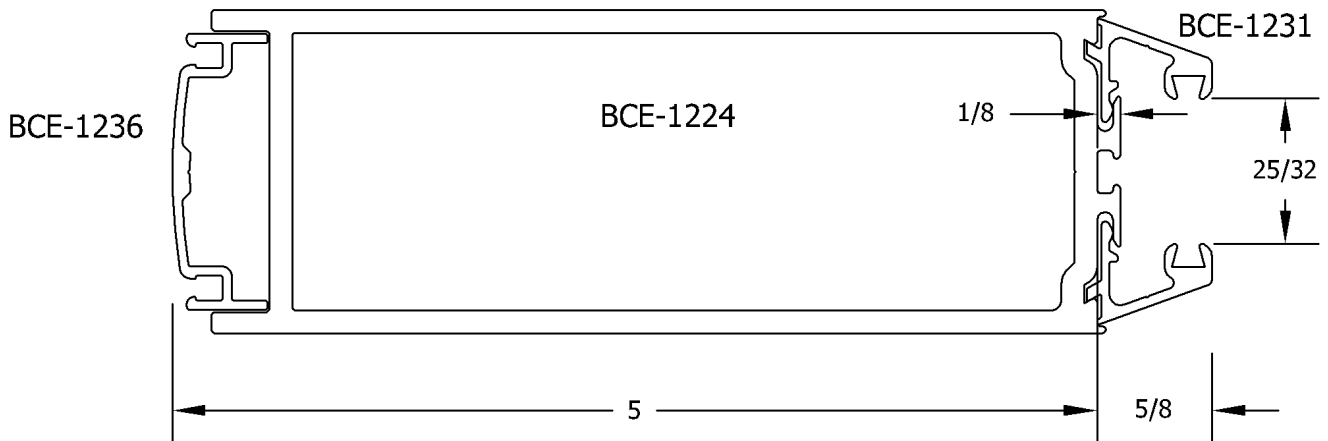
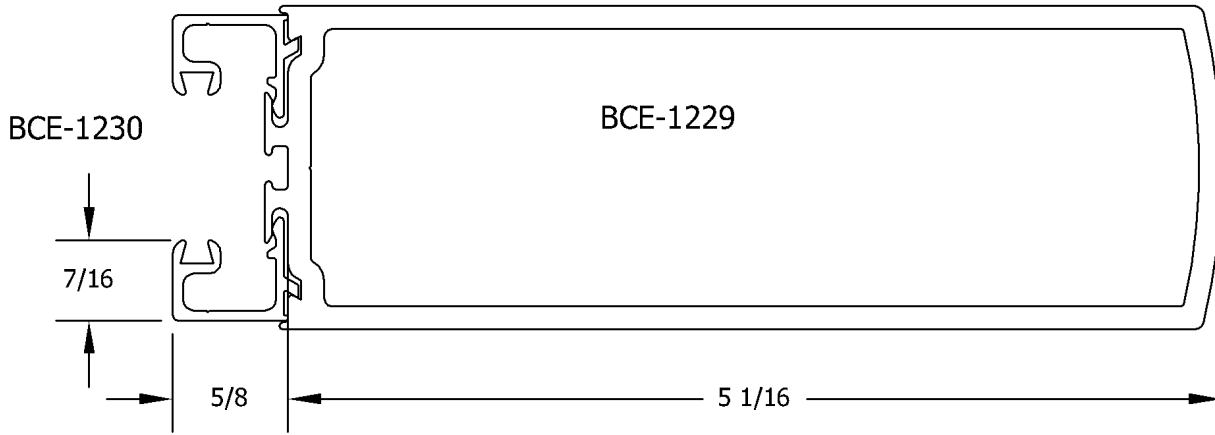
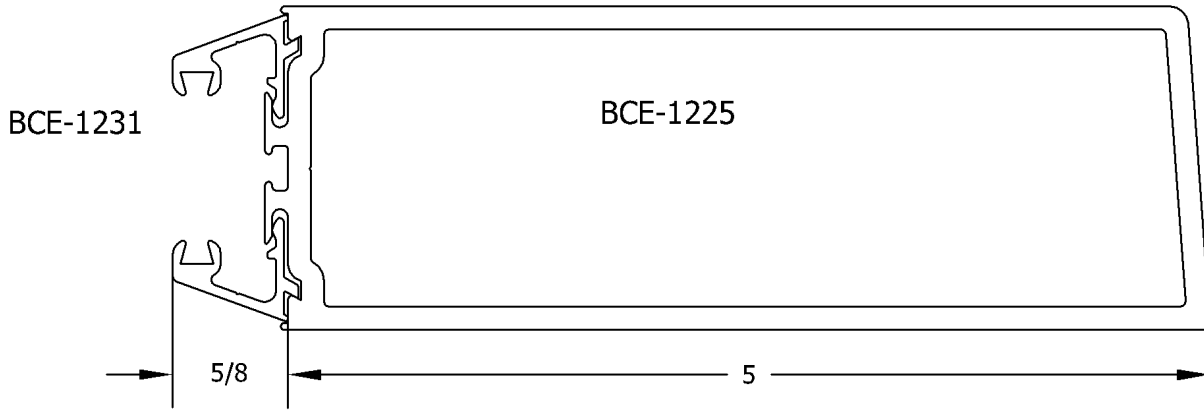

1200 SERIES ENTRANCE
DOOR ACCESSORIES

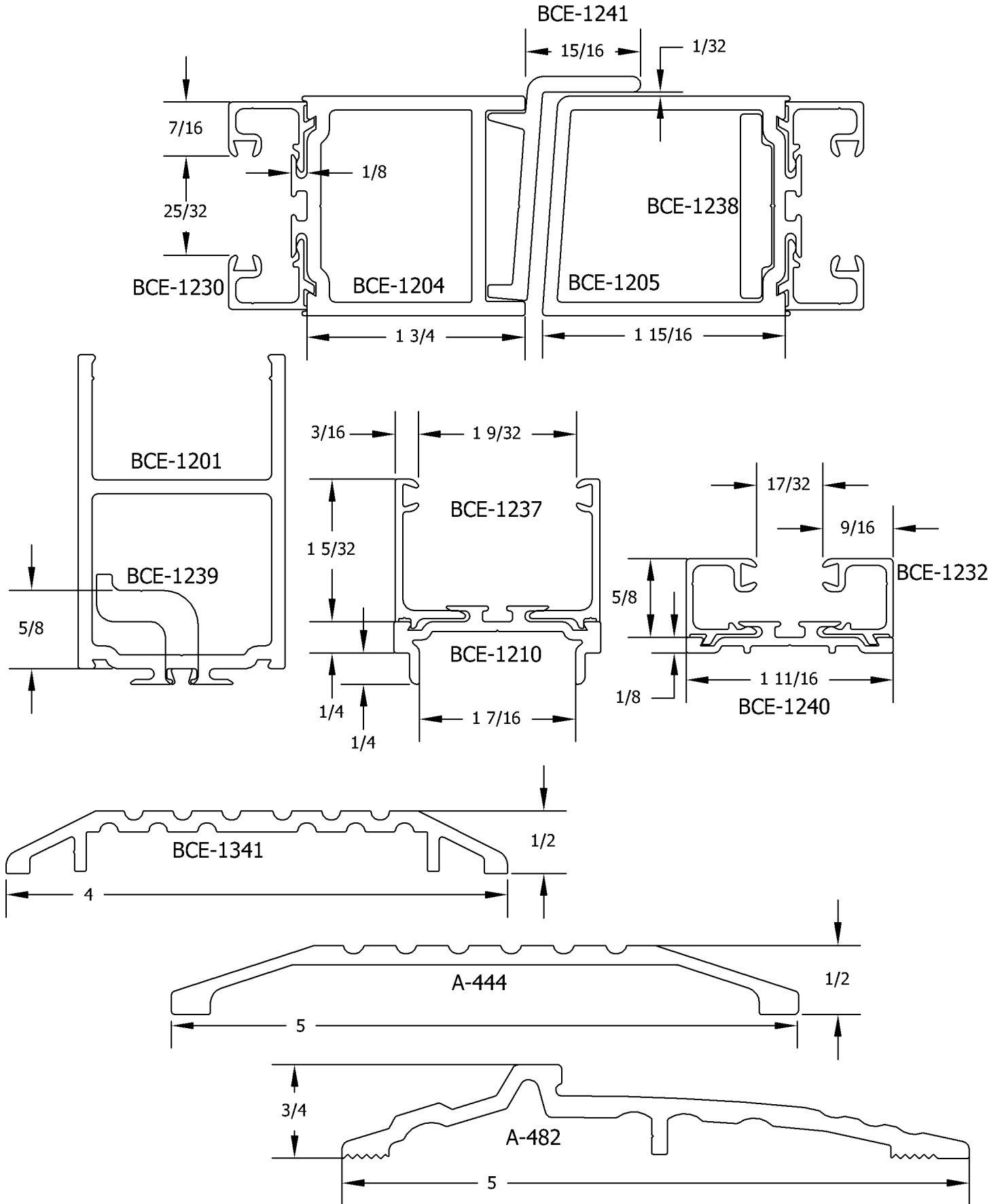

1200 SERIES ENTRANCE
DOOR ACCESSORIES

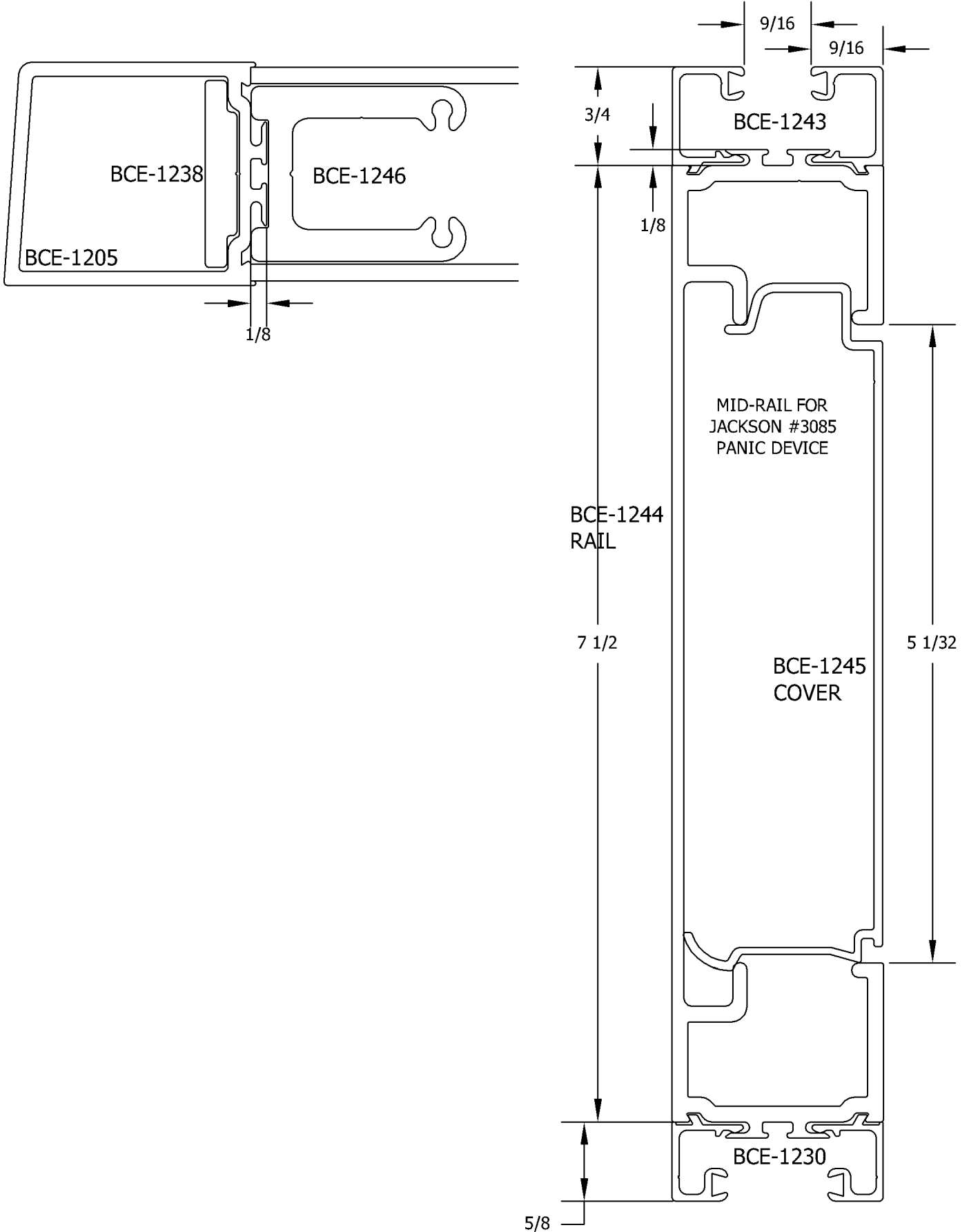

1200 SERIES ENTRANCE
DOOR



SCALE= 3/4 : 1

