

1/4 SIZE DETAILS

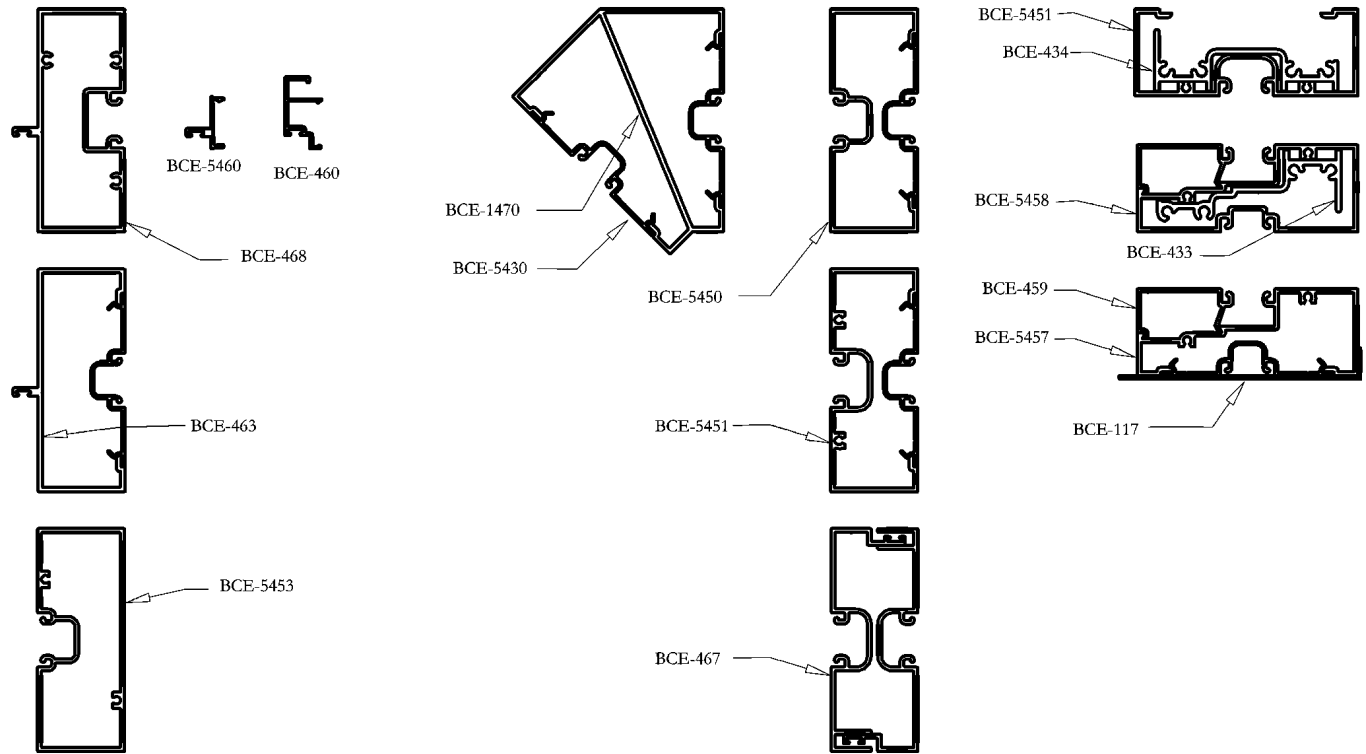

THIS SYSTEM IS DESIGNED TO BE ASSEMBLED WITH #10 SCREWS



<u>GASKETS</u>		
REED RUBBER PRODUCTS 800-325-9698	#3734 #4893	INTERIOR & EXTERIOR ALTERNATIVE
UNIVERSAL RUBBER CO. 800-782-2375	#2028	INTERIOR & EXTERIOR
TREMCO 800-321-6357	TR-2062E	INTERIOR & EXTERIOR

<u>DOOR PILE</u>		
SCHLEGEL CORP. 800-828-6237	AS SELECTED	USED WITH BCE-460 AND LIKE SHAPES
AMESBURY GROUP INC. 704-878-6892	AS SELECTED	USED WITH BCE-460 AND LIKE SHAPES

NO TEST DATA AVAILABLE
TREDEGAR EXTRUSIONS INC. DOES NOT MAKE ANY WARRANTY EXPRESS OR IMPLIED INCLUDING
NO WARRANTY OF MERCHANTABILITY OR FITNESS FOR A PARTICULAR PURPOSE AND RESERVES
THE RIGHT TO MAKE CHANGES
REPRODUCTION RIGHTS RESERVED

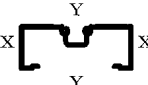
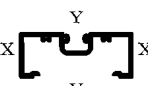
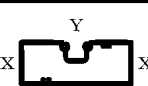
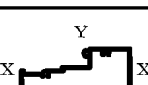
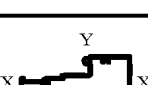
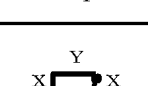
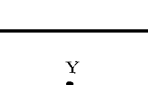
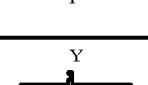
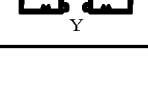
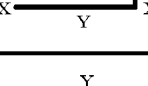
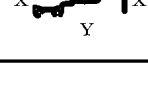
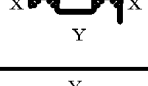
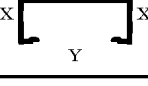
PRICING FACTORS
1 3/4" X 4 1/2" FLUSH GLAZED
BCE-5450 SERIES

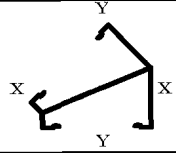
WEIGHT PER FT	EST PER	FACTOR	CAVITY AREA	PART NUMBER	STRUCTURAL VALUES			1/8 SIZE DETAILS
					X-X	I	Y-Y	
0.424	11.489	27	N/A	BCE5430	0.016	I	0.320	
					0.034	S	0.183	
1.078	22.383	21	N/A	BCE5450	0.330	I	2.398	
					0.296	S	1.066	
1.184	24.602	21	N/A	BCE5451	0.346	I	2.446	
					0.301	S	1.087	
1.417	14.971	21	N/A	BCE5453	0.575	I	2.627	
					0.641	S	1.168	
1.016	20.989	21	N/A	BCE5457	0.265	I	2.019	
					0.286	S	0.826	
1.402	15.319	21	N/A	BCE5458	0.402	I	2.174	
					0.391	S	0.912	
0.295	8.202	28	N/A	BCE459	0.021	I	0.129	
					0.030	S	0.132	
0.162	4.371	27	N/A	BCE5460	0.005	I	0.012	
					0.011	S	0.019	
1.656	17.044	19	N/A	BCE468	0.697	I	2.858	
					0.521	S	1.260	
0.404	10.982	27	N/A	BCE117	0.004	I	0.780	
					0.007	S	0.290	
0.899	14.003	16	N/A	BCE433	0.106	I	1.103	
					0.143	S	0.518	
0.979	15.098	15	N/A	BCE434	0.058	I	1.271	
					0.074	S	0.636	
1.069	19.896	19	N/A	BCE463	0.413	I	2.580	
					0.346	S	1.140	
0.943	20.196	21	N/A	BCE467	0.111	I	1.758	
					0.100	S	0.748	

WEIGHT PER FT	EST PER	FACTOR	CAVITY AREA	PART NUMBER	STRUCTURAL VALUES			1/8 SIZE DETAILS
					X-X		Y-Y	
1.424	27.580	19	N/A	BCE1470	1.619	I	3.345	
					0.625	S	1.143	
0.251	7.076	28	N/A	BCE460	0.010	I	0.043	
					0.020	S	0.056	

WINDLOAD CHARTS
1 3/4" X 4 1/2" FLUSH GLAZED
BCE-5450 SERIES

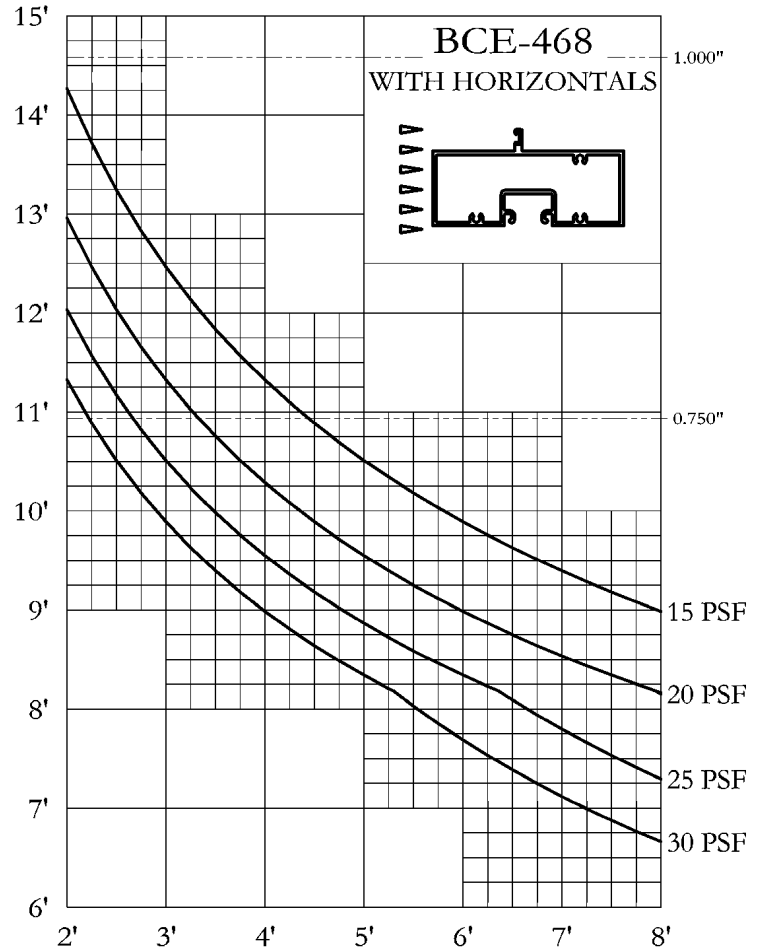
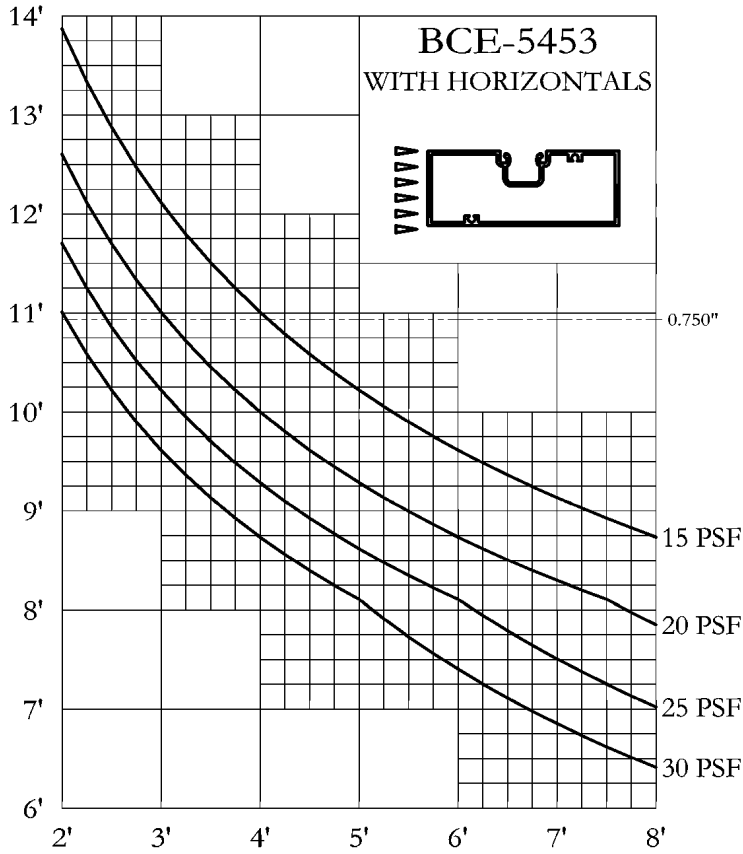

#1 THESE WINDLOAD CHARTS ARE BASED UPON THE LESSER OF DEFLECTION RATIO (L/175) OR STRESS (12667)

#2 THESE STRUCTURAL CURVES ARE ESTIMATES AND ARE PRESENTED TO THE BEST KNOWLEDGE OF THE WILLIAM L BONNELL CO. IT IS, HOWEVER, THE RESPONSIBILITY OF THE CUSTOMER TO BE SATISFIED THAT THE CURVES ARE CORRECT. THE WILLIAM L BONNELL CO. MAY NOT BE HELD RESPONSIBLE IN ANY WAY FOR THE FAILURE OF PERFORMANCE RESULTING FROM THE USE OF THESE CURVES.

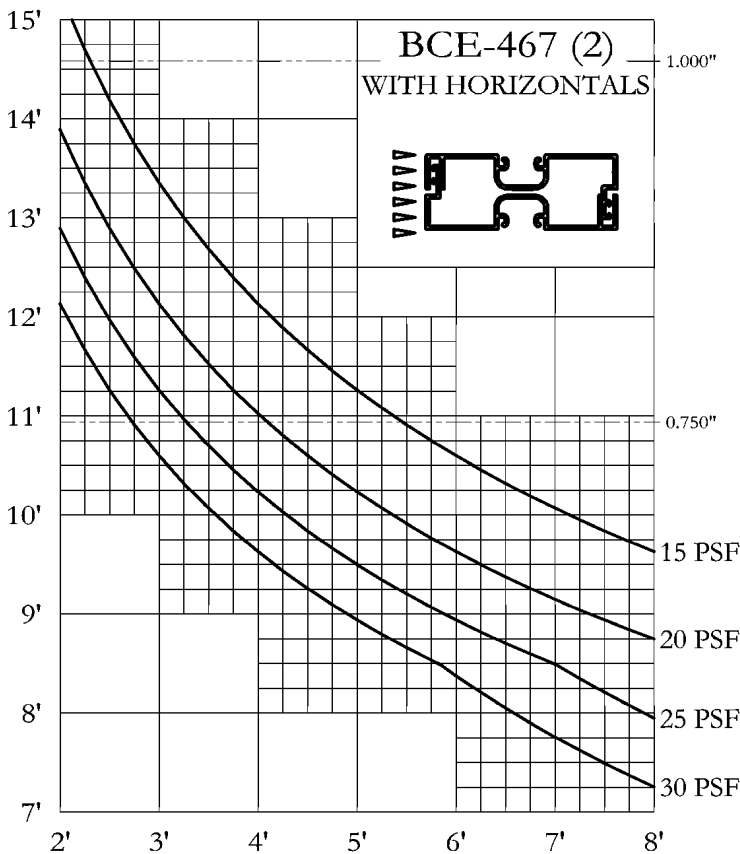
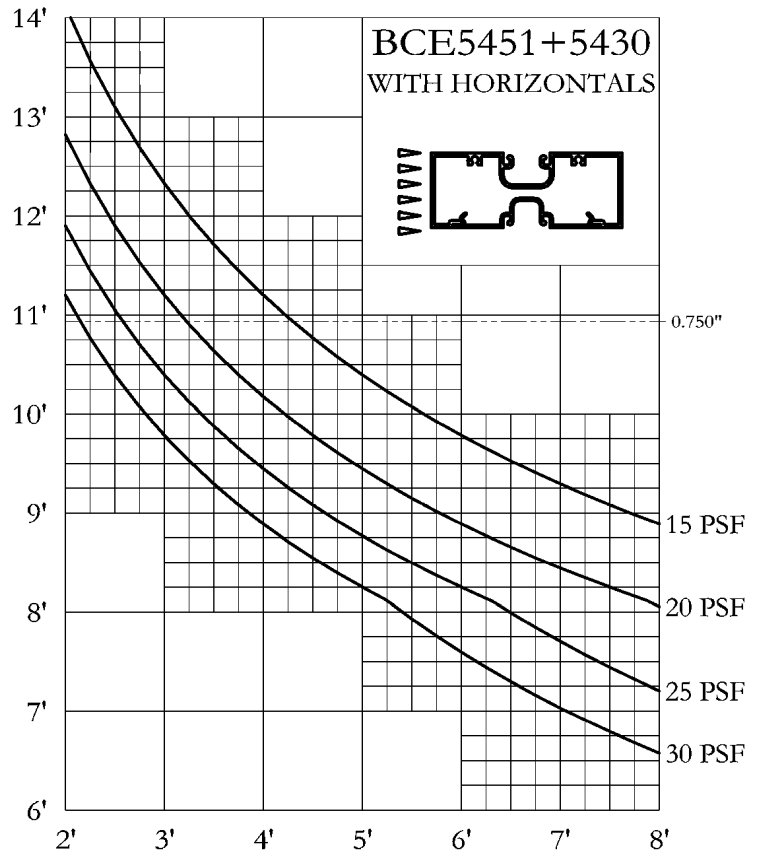
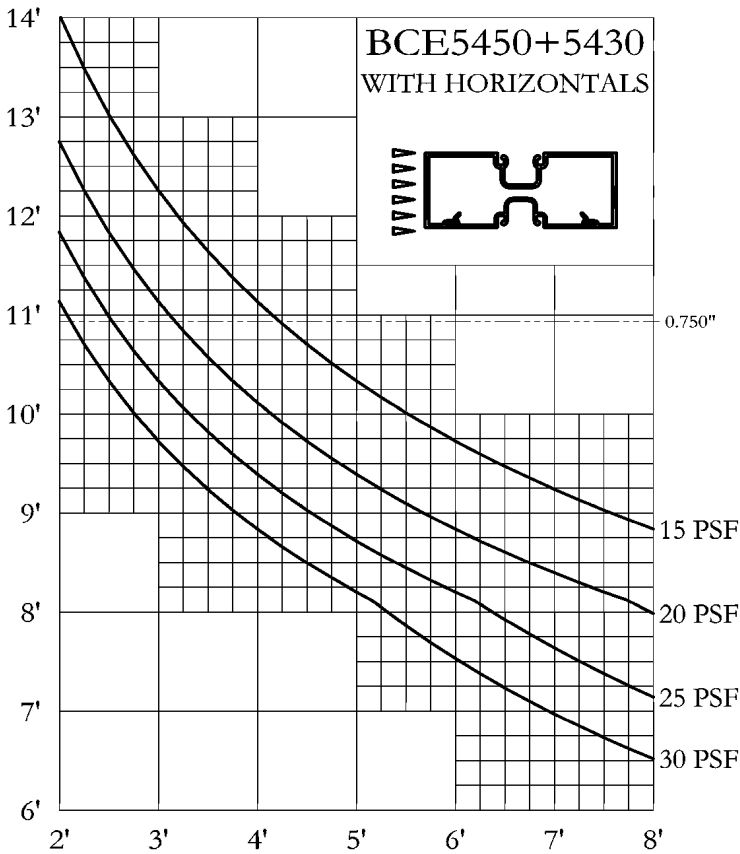

#1 THESE WINDLOAD CHARTS ARE BASED UPON THE LESSER OF DEFLECTION RATIO (L/175) OR STRESS (12667)

#2 THESE STRUCTURAL CURVES ARE ESTIMATES AND ARE PRESENTED TO THE BEST KNOWLEDGE OF THE WILLIAM L BONNELL CO. IT IS, HOWEVER, THE RESPONSIBILITY OF THE CUSTOMER TO BE SATISFIED THAT THE CURVES ARE CORRECT. THE WILLIAM L BONNELL CO. MAY NOT BE HELD RESPONSIBLE IN ANY WAY FOR THE FAILURE OF PERFORMANCE RESULTING FROM THE USE OF THESE CURVES.

WINDLOAD CHARTS
1 3/4" X 4 1/2" FLUSH GLAZED
BCE-5450 SERIES

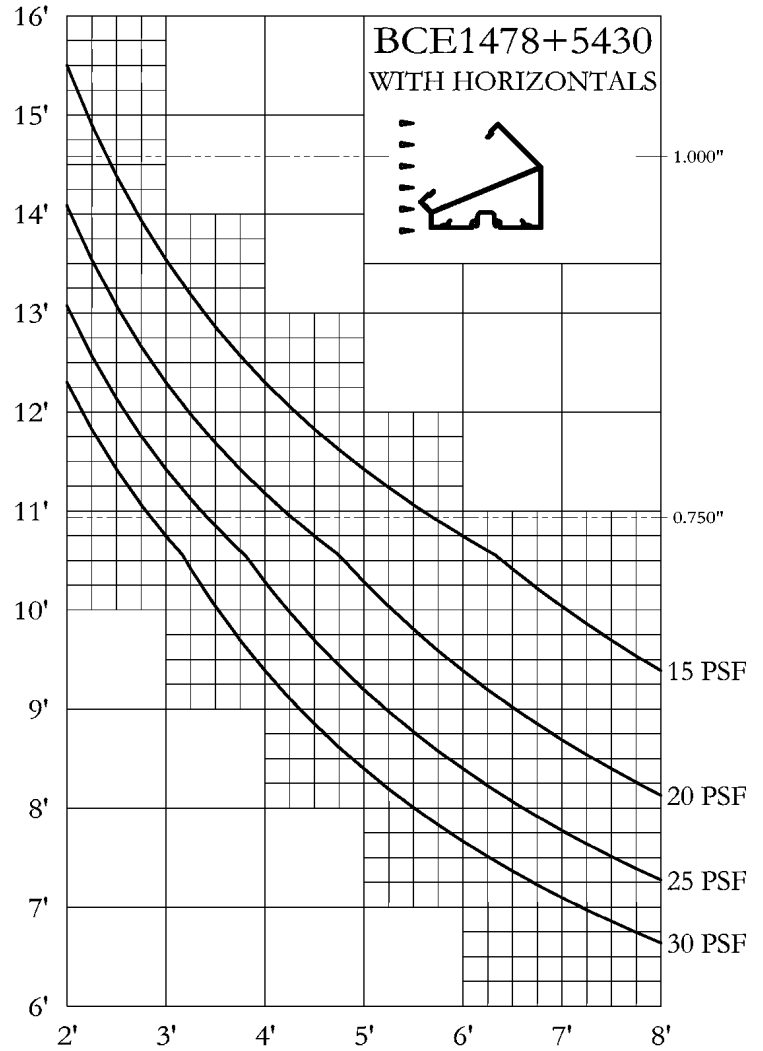
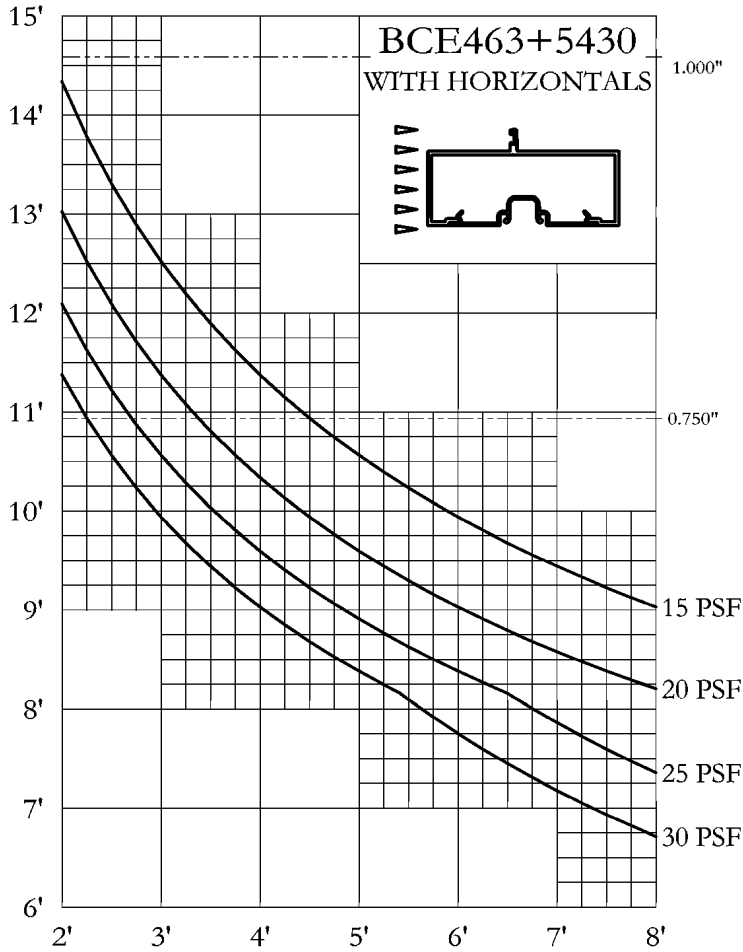

#1 THESE WINDLOAD CHARTS ARE BASED UPON THE LESSER OF DEFLECTION RATIO ($L/175$) OR STRESS (12667)

#2 THESE STRUCTURAL CURVES ARE ESTIMATES AND ARE PRESENTED TO THE BEST KNOWLEDGE OF THE WILLIAM L BONNELL CO. IT IS, HOWEVER, THE RESPONSIBILITY OF THE CUSTOMER TO BE SATISFIED THAT THE CURVES ARE CORRECT. THE WILLIAM L BONNELL CO. MAY NOT BE HELD RESPONSIBLE IN ANY WAY FOR THE FAILURE OF PERFORMANCE RESULTING FROM THE USE OF THESE CURVES.

FULL SIZE DETAILS

BCE-117

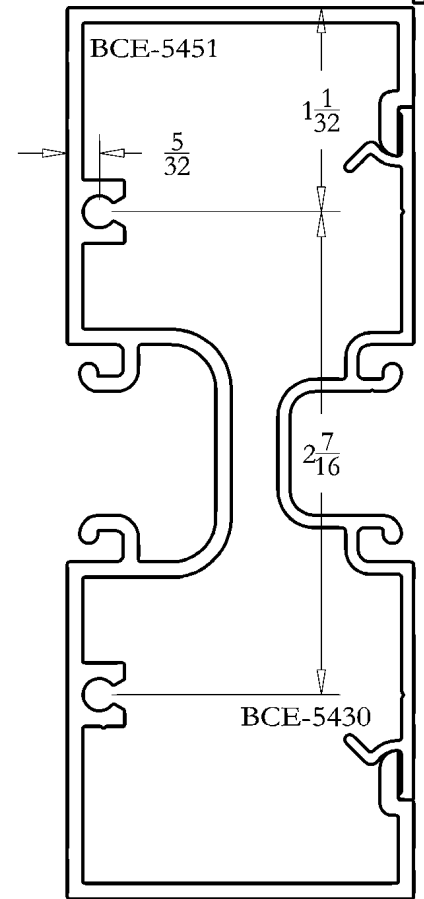
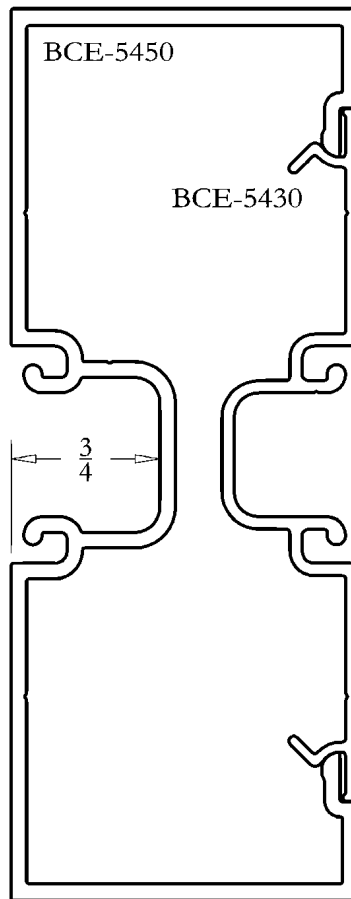
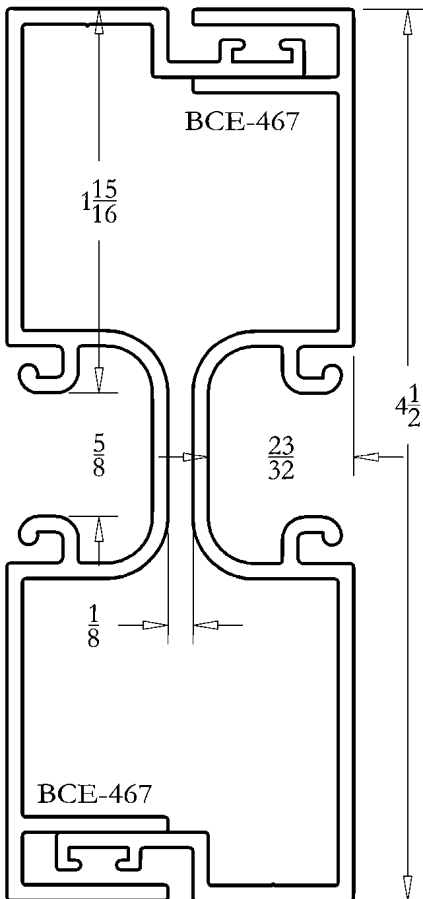
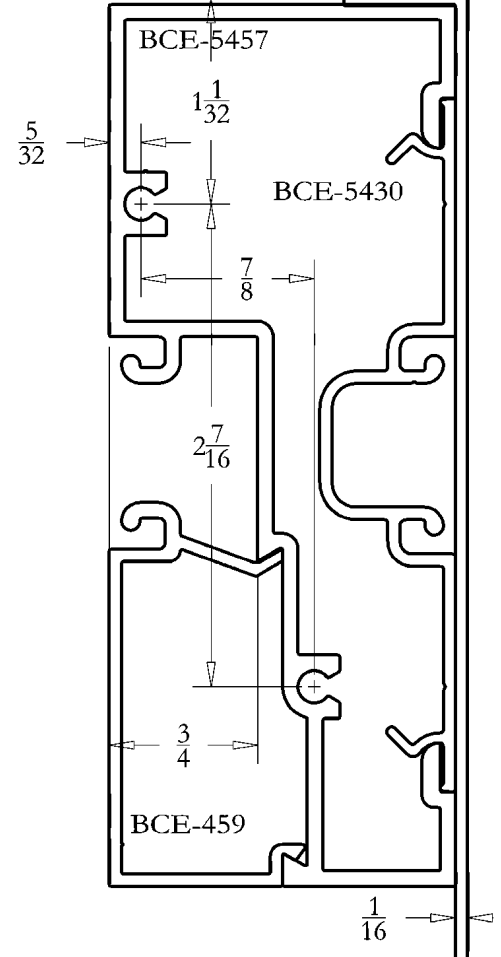
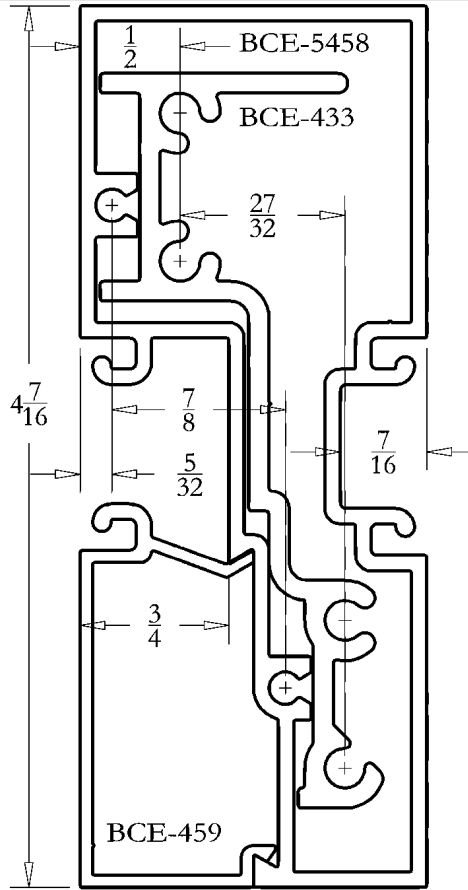
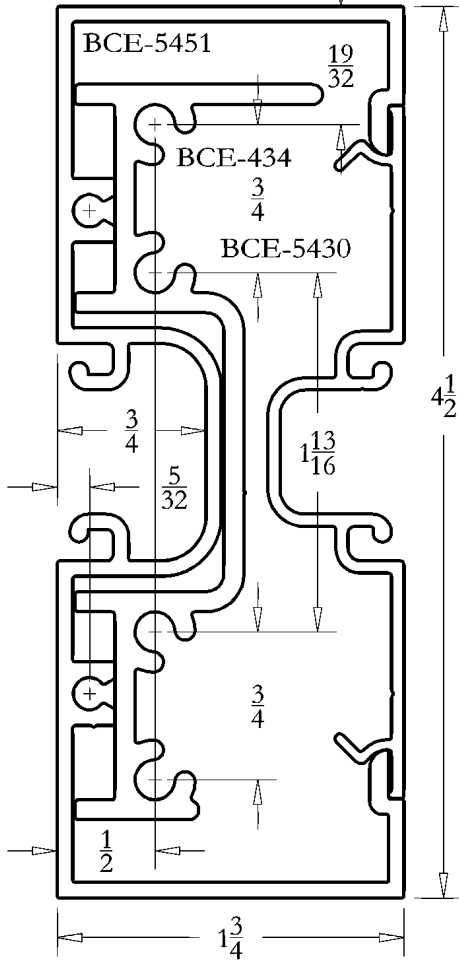

DETAIL SHEET
1 3/4" X 4 1/2" FLUSH GLAZED
BCE-5450

FULL SIZE DETAILS

